

Screw Driven automation tables

Precise multi-axis positioning systems play an integral part in today's semiconductor, computer peripheral, solar power, flat panel, life sciences, lab automation, biomedical and electronics industries. The demands for tighter specifications, improved throughput and consistent quality have become increasingly stringent. Because of the complexity associated with these systems, many manufacturers insist on a single source supplier to eliminate multiple vendor design incompatibilities and delivery conflicts. With over forty years' experience as a global leader in the development of products and technology, Parker provides the most advanced, easy to integrate high-precision electromechanical systems.

Contents

30-33	Overview
34-63	400XR Series Precision Linear Positioners
64-69	XRS Cartesian Systems
70-79	402/403XE Series Positioners
80-89	404XE Series Positioners
90-111	HD Series Industrial Linear Positioners
112-127	Ultra Series Precision Stages
128-133	100CT & 800CT Series Tables
134-137	200RT Series Rotary Tables
138-141	R Series Worm Drive Rotary Tables
142-145	ZP200 Series Vertical Lift "Wedge" Table
146-150	Additional Products



天津昕科佳业科技有限公司

地址：天津市红桥区咸阳北路开源楼32-409

电话：022-86559825

网址：www.xinkejiaye.com

ZP200 Series Vertical Lift “Wedge” Table

Features

- Precision platform for vertical (Z-axis) positioning
- Continuous duty - High dynamic performance
- Precision straightness (± 5 arc-sec) throughout range of motion
- Precision ground ballscrew drive - 5, 10, or 20 mm lead
- Multi-axis compatibility with XR and LXR tables
- Laser tested and certified with calibrated lead value

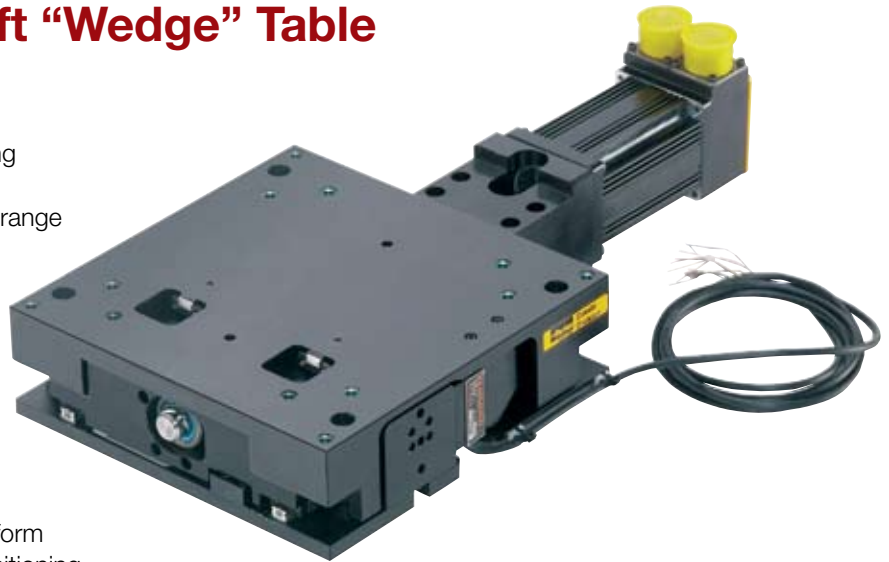

Quality Design and Construction

The ZP200 Z axis lift table is a stable support platform which provides precise vertical translation and positioning, while maintaining X-Y integrity. Recirculating square rail bearings are incorporated into a unique variation of “wedge” mechanics to enable reliable high dynamic performance without the potential loss of travel encountered with cross roller bearings. The ZP200 is compatible with XR and LXR tables for multi-axis systems, and it can be utilized as the system base axis or top axis to fit the motion requirements of the application. Standard mounting holes and dowel pin holes accommodate repeatable mounting.

Options

- Linear Encoder option with selectable resolutions of 0.1, 0.5, 1.0 μm
- Fail-safe brake (field installable - mounts directly to the ballscrew drive)
- Class 10 cleanroom preparation
- Selectable motor mounting and couplings for SM16 or NEMA 23 servo or stepper motors
- Easily adjusted travel “limit” and “home” sensors are provided in an enclosed sensor pack

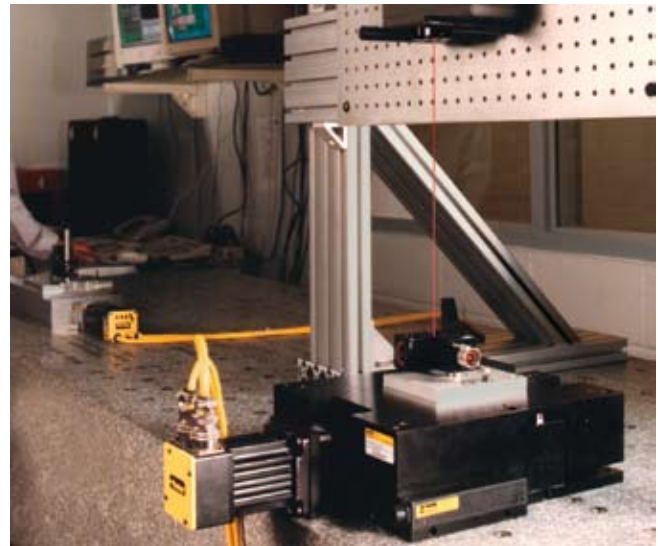

ZP200 utilized in a laser test set-up

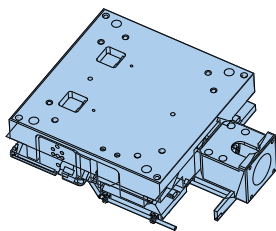

Encoder

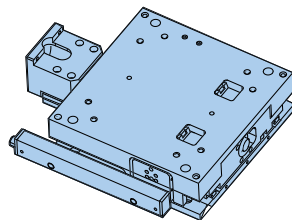

Sensor Pack



ZP200 Specifications

	Precision	Standard
Travel (Z-axis)	25 mm (limit to limit)	25 mm (limit to limit)
Positional Accuracy		
with no encoder ^{1,2,7}	8 μm	20 μm
with linear encoder ^{3,6,7}	8 μm	—
Positional Repeatability		
with no encoder ^{1,7}	± 3 μm	± 10 μm
with 1.0 μm linear encoder ^{6,7}	± 5 μm	—
with 0.5 μm linear encoder ^{6,7}	± 4 μm	—
with 0.1 μm linear encoder ^{6,7}	± 3 μm	—
Lift Lead Ratio ⁴		
5 mm lead ballscrew drive	1.8199 mm/rev	
10 mm lead ballscrew drive	3.6397 mm/rev	
20 mm lead ballscrew drive	7.2794 mm/rev	
Lift Velocity		
5 mm lead ballscrew drive	110 mm/sec	
10 mm lead ballscrew drive	220 mm/sec	
20 mm lead ballscrew drive	440 mm/sec	
Load Capacity (normal)	15 kg (33 lb)	75 kg (165 lb)
Duty Cycle	100%	
Max Acceleration	7.2 m/sec ²	
Efficiency	90%	
Max Breakaway Torque ⁵	0.15 Nm	
Max Running Torque ⁵	0.13 Nm	
Linear Bearing – Coefficient Of Friction	0.01	
Ballscrew Diameter	16 mm	
Unit Weight	5.82 kg	
Top Plate Weight	2.25 kg	
Pitch ⁷	± 15 Arc-sec	± 45 Arc-sec
Roll ⁷	± 15 Arc-sec	± 25 Arc-sec
Input Inertia		
5 mm lead ballscrew drive	2.32 x 10 ⁻⁵ Kg-m ²	
10 mm lead ballscrew drive	2.51 x 10 ⁻⁵ Kg-m ²	
20 mm lead ballscrew drive	3.12 x 10 ⁻⁵ Kg-m ²	

Screw Driven Tables

- 1) Measured 38 mm directly above the true center of the top mounting surface.
- 2) Measured using calibrated lead value (provided).
- 3) Slope correction value provided
- 4) Lift per 1 motor shaft revolution. Lift lead listed is nominal. All units are provided with calibrated lead value.
- 5) Torque ratings are measured with unit unloaded, traveling upward.
- 6) Measured directly over encoder on outer edge.
- 7) Pitch and Roll Specifications are measured with <1kg load. Addition of load increases pitch and roll error by 10 arc-sec per 5 kg of load assuming the load center of gravity is located at the center of the stage platform. Cantilevered loading increases these errors more.

Table Life/Compression (Normal) Load

The graph provides a preliminary evaluation of the support bearing life/load characteristics. The curves show the life/load relationship when the applied load is centered on the carriage, normal (perpendicular) to the carriage mounting surface. For final evaluation of life vs load, including off center, tension, and side loads contact Parker Applications Engineering at 800-245-6903.

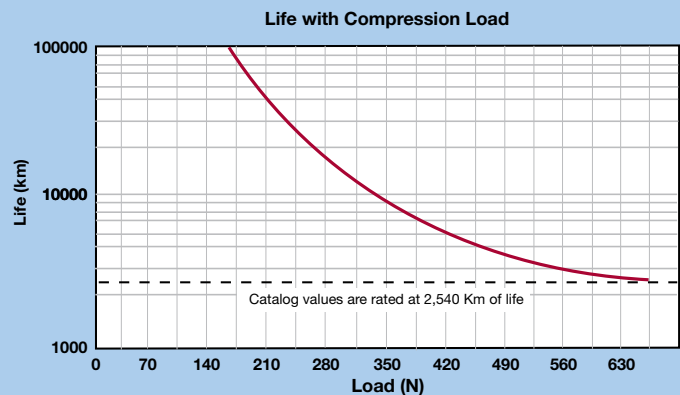

ZP200 Series Dimensions

Dimensions - inches (mm)

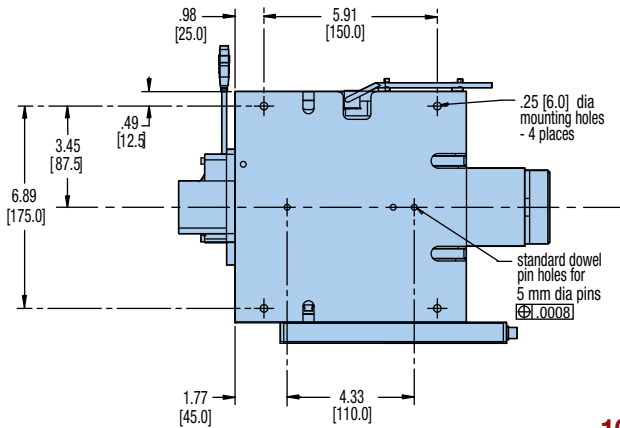
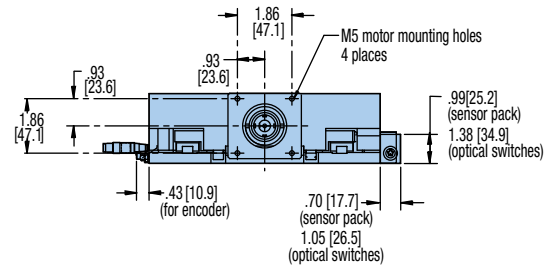
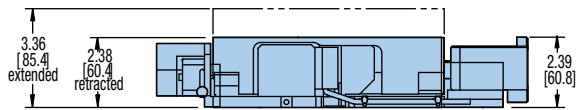
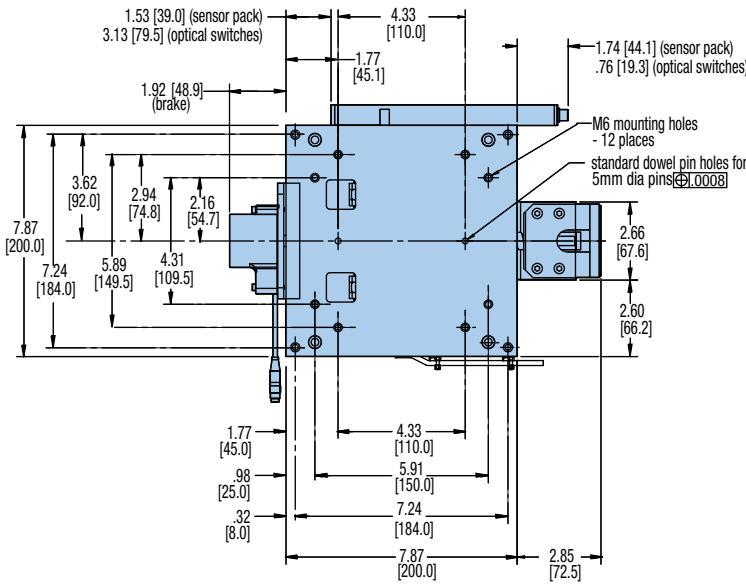

100-9274-01 XR Adapter Plate

A multi-axis adapter plate is available to mount the ZP200 to an XR/LXR table or, mount an XR/LXR table to the ZP200. This plate is 9.53 mm thick and includes standard dowel pin holes for repeatable alignment.

	ZP200 as Base	ZP200 as Top Axis
404XR	Yes	—*
404LXR	Yes	—*
406XR	Yes	Yes
406LXR	Yes	Yes
206 Rotary	Yes	—*

*Not recommended - consult factory.



Fill in an order code from each of the numbered fields to create a complete model order code.

① ② ③ ④ ⑤ ⑥ ⑦ ⑧ ⑨ ⑩ ⑪ ⑫ ⑬

Order Example: ZP200 T01 M S D2 H12 L12 C3 M3 E3 B2 R1 P1

① Series

ZP200

② Travel

T01 25 mm

③ Mounting

M Metric

④ Grade

P Precision
S Standard

⑤ Drive Screw

D2 5 mm lead
D3 10 mm lead
D4 20 mm lead

⑥ Home Sensor

H1 No sensor
H11 N.C. current sinking, sensor pack
H12 N.O. current sinking, sensor pack
H13 N.C. current sourcing, sensor pack
H14 N.O. current sourcing, sensor pack

⑦ Travel Limit Sensors

L1 No sensor
L11 N.C. current sinking, sensor pack
L12 N.O. current sinking, sensor pack
L13 N.C. current sourcing, sensor pack
L14 N.O. current sourcing, sensor pack

⑧ Coupling

C1 No coupling
C3 0.25" bore bellows
C5 0.38" bore bellows
C23 9.0 mm (0.35") bore bellows

⑨ Motor Mount

M1 No motor mounts
M2 SM16/BE16 motor
M3 NEMA 23 and SM23 motors
M61 BE23 motor mount

⑩ Linear Encoder Option

E1 No encoder
E2 1.0 micron
E3 0.5 micron
E4 0.1 micron
E5 5.0 micron
E7 Sine/cosine encoder

⑪ Brake Option

B1 No brake
B2 Shaft brake

⑫ Environmental

R1 Class 1000
R2 Class 10

⑬ P1

Place holder

Screw Driven
Tables



天津昕科佳业科技有限公司

地址：天津市红桥区咸阳北路开源楼32-409

电话：022-86559825

网址：www.xinkejiaye.com